

Government Notice No. 131 of 2022

THE ENERGY EFFICIENCY ACT

**Regulations made by the Minister under section 23
of the Energy Efficiency Act**

1. These regulations may be cited as the Energy Efficiency (Labelling of Regulated Machinery) (Amendment) Regulations 2022.
2. In these regulations –
“principal regulations” means the Energy Efficiency (Labelling of Regulated Machinery) Regulations 2017.
3. Regulation 2 of the principal regulations is amended –
 - (a) by inserting, in the appropriate alphabetical order, the following new definition –
“European Union Commission Delegated Regulation” means a regulation which has been adopted by the European Commission of the European Union (EU), supplementing Regulation (EU) 2017/1369 of the European Parliament, with regards to energy labelling of a regulated machinery;
 - (b) in the definitions of “product certificate” and “test report”, by deleting the words “Mauritian Standard set out in the second column of the First Schedule” and replacing them by the words “standard set out in the second and third columns of the First Schedule”.
4. Regulation 4 of the principal regulations is amended, in paragraph (2)(a), by deleting the words “Mauritian Standard set out in the second column of the First Schedule” and replacing them by

the words “standard set out in the second and third columns of the First Schedule”.

5. Regulation 5 of the principal regulations is amended, in paragraphs (2)(c), (3), (5) and (6), by deleting the words “Mauritian Standard set out in the second column of the First Schedule” and replacing them by the words “standard set out in the second and third columns of the First Schedule”.

6. The principal regulations are amended by adding the following new regulations –

8. The provisions of the second column of the First Schedule shall remain in force until 31 August 2022

7. The First Schedule to the principal regulations is revoked and replaced by the First Schedule set out in the Schedule to these regulations.

8. The Second Schedule to the principal regulations is amended –

(a) in item 1 –

(i) by deleting sub-items (3) to (5) and replacing them by the following sub-items –

(3) Professional refrigerated storage cabinets and blast cabinets, except for professional chest freezers

(4) Refrigerating appliances with a direct sales function

(5) Mobile refrigerating appliances

(ii) by adding the following new sub-item –

(6) Appliances where the primary function is not the storage of foodstuffs through refrigeration

(b) by adding the following new item –

3. Household dishwashers

Battery-operated household dishwashers that can be connected to the mains through an AC/DC converter purchased separately

9. The Third Schedule to the principal regulations is revoked and replaced by the Third Schedule set out in the Second Schedule to these regulations.

10. These regulations shall come into operation on 1 June 2022.

Made by the Minister on 18 May 2022.

FIRST SCHEDULE

[Regulation 7]

FIRST SCHEDULE

[Regulations 2, 3(b), 4(2)(a) and 5(2)(c), (3), (5) and (6)]

| Regulated machinery | Mauritian standard | EU Commission Delegated Regulation |
|------------------------------------|---------------------------|---|
| Household electric dishwashers | MS 205 | (EU) 2019/2017 |
| Household electric ovens | MS 204 | (EU) 65/2014 |
| Household refrigerating appliances | MS 201 | (EU) 2019/2016 |

SECOND SCHEDULE

[Regulation 9]

THIRD SCHEDULE

[Regulation 4(2)(b)]

**PART I – HOUSEHOLD REFRIGERATING APPLIANCES
(MS 201)**

Type 1 – Label for household refrigerating appliances classified in energy efficiency classes A⁺⁺⁺ to C (except for wine storage appliances)

A – Label Content

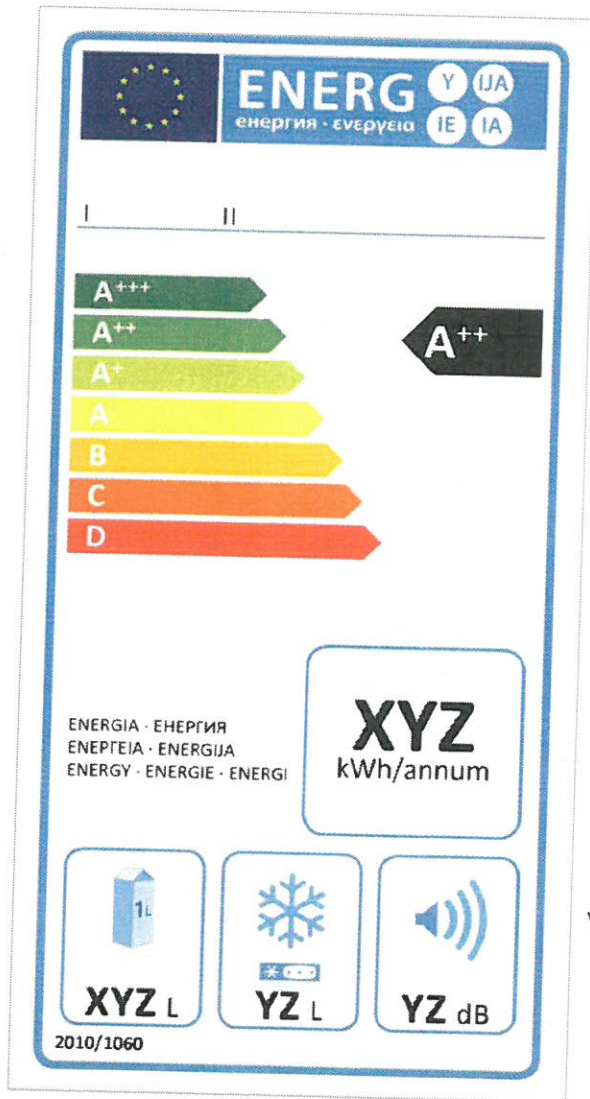

The following information shall be included in the label –

- (I) the supplier's name or trade mark;
- (II) the supplier's model identifier;
- (III) the energy efficiency class determined in accordance with clause 5.2 of MS 201. The head of the arrow containing the energy efficiency class of the household refrigerating appliance shall be placed at the same height as the head of the arrow of the relevant energy efficiency class;
- (IV) the annual energy consumption (AE_c) in kilowatt-hour per year, rounded up to the nearest integer and calculated in accordance with point 2(2) of Annex V of MS 201;
- (V) the sum of the storage volumes of all compartments that do not merit a star rating (i.e. operating temperature more than -6°C, rounded to the nearest integer;
- (VI) the sum of the storage volumes of all frozen-food storage compartments that merit a star rating (i.e. operating temperature less than and equal to -6 °C, rounded to the nearest integer and star rating of the compartment with the highest share of that sum; where the household refrigerating appliances has no frozen food storage compartment(s) the supplier shall declare '-L' instead of a value and leave the position for star rating blank;
- (VII) the airborne acoustical noise emissions expressed in dB(A) re1 pW, rounded to the nearest integer.

B – Label Design

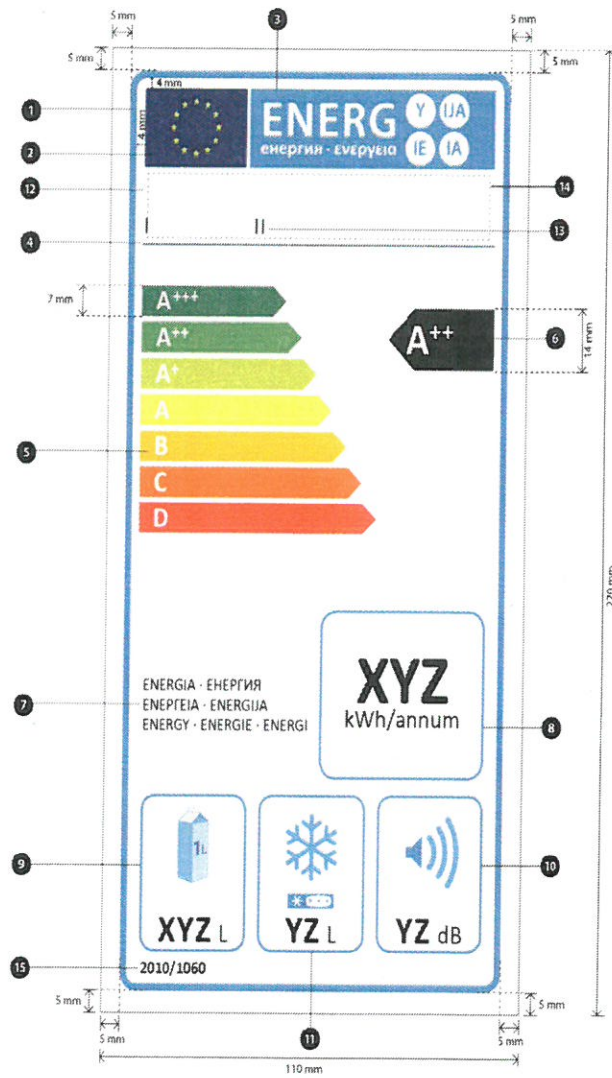

Whereby –

- (a) (i) the label shall be at least 110 mm wide and 220 mm high;
- (ii) where the label is printed in a larger format, its content shall nevertheless remain proportionate to the specifications above;
- (b) the background of the label shall be white;
- (c) colours shall be CMYK – cyan, magenta, yellow and black, following this example: 00-70-X-00: 0% cyan, 70% magenta, 100 per cent yellow, 0% black;
- (d) the label shall fulfil all of the following requirements (numbers refer to the figure above) –
 - 1. the EU label border stroke –
5 pt – colour: cyan 100% – round corners: 3.5 millimetres;
 - 2. the EU logo –
colours: X-80-00-00 and 00-00-X-00;
 - 3. the energy label: colour: X-00-00-00 –
the EU logo + energy label: width: 92 millimetres, height: 17 millimetres;
 - 4. the sub-logos border –
1 pt – colour: cyan 100% – length: 92.5 millimetres;
 - 5. the A-G scale –
arrow: height: 7 millimetres, gap: 0.75 millimetres
– colours –
highest class: X-00-X-00;
second class: 70-00-X-00;

third class: 30-00-X-00;

fourth class: 00-00-X-00;

fifth class: 00-30-X-00;

sixth class: 00-70-X-00;

last class: 00-X-X-00;

text: **calibri bold 19 pt, capitals and white, '+' symbols:**
Calibri bold 13 pt, capitals, white, aligned on a single row;

6. the energy efficiency class –

arrow: width: 26 millimetres, height: 14 millimetres, 100% black;

text: **calibri bold 29 pt, capitals and white, '+' symbols:**
calibri bold 18 pt, capitals, white and aligned on a single row;

7. the energy –

text: **calibri regular 11 pt, capitals, black;**

8. the annual energy consumption –

border: 3 pt – colour: cyan 100% – round corners: 3.5 millimetres;

value: **calibri bold 45 pt, 100% black;**

second line: **calibri regular 17 pt, 100% black;**

9. the storage volumes of all compartments that do not merit a star rating –

border: 3 pt – colour: cyan 100% – round corners: 3.5 millimetres;

value: **Calibri bold 25 pt, 100% black,calibri regular 17 pt, 100% black;**

10. the airborne acoustical noise emissions –
border: 3 pt – colour: Cyan 100% – round corners: 3.5 millimetres;
value: calibri bold 25 pt, 100% black, and calibri regular 17 pt, 100% black;
11. the storage volumes of all frozen-food storage compartments that merit a star rating–
border: 3 pt – colour: cyan 100% – round corners: 3.5 millimetres;
value: calibri bold 25 pt, 100% black, calibri regular 17 pt, 100% black;
12. the supplier's name or trademark;
13. the supplier's model identifier;
14. the supplier's name or trademark and model identifier should fit in a space of 90 x 15 mm;
15. numbering of the regulation –
text: calibri bold 11 pt.

Type 2 – Label for household refrigerating appliances classified in energy efficiency classes D to G (except for wine storage appliances)

A – Label Content

The content of the label shall be similar to the content of the label for Type 1 – Label for household refrigerating appliances classified in energy efficiency classes A⁺⁺⁺ to C (except for wine storage appliances).

B – Label Design

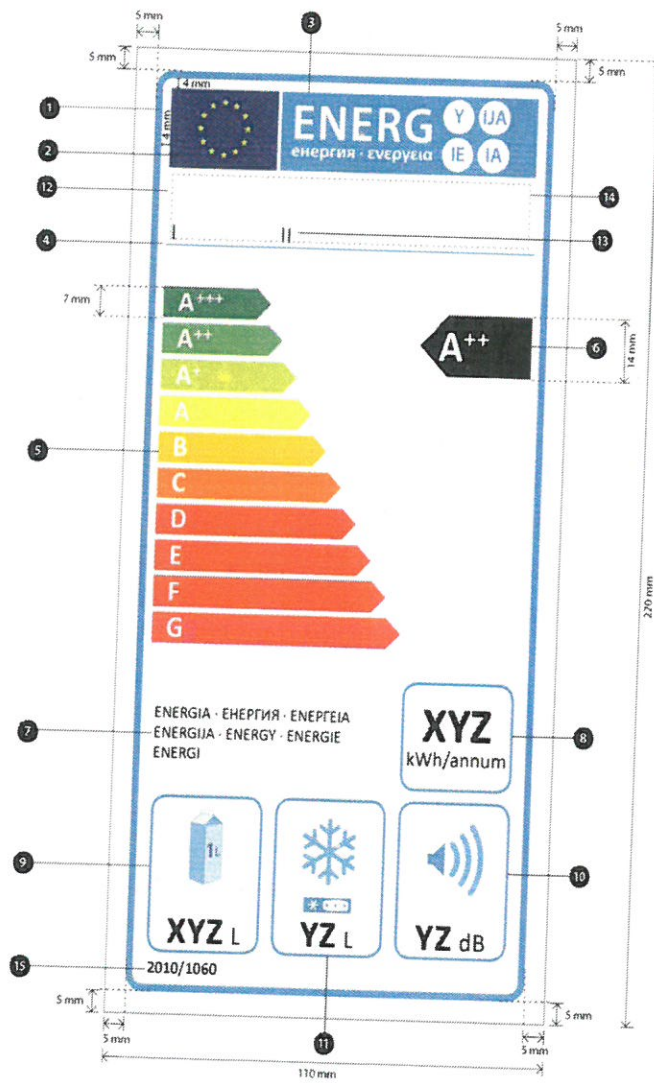

Whereby –

- (a) the design of the label shall be similar to the design of the label for Type 1 – Label for household refrigerating appliances classified in energy efficiency classes A⁺⁺⁺ to C (except for wine storage appliances), except that, in paragraph (d), item (8) shall be replaced by the following item –

8. annual energy consumption –

border: 3 pt – colour: Cyan 100% – round corners: 3.5 millimetres;

value: Calibri bold 32 pt, 100% black;

second line: calibri regular 14 pt, 100% black;

Type 3 – Label for Wine Storage Appliances

A – Label Content

- (b) the content of the label shall be similar to the content of the label for type 1 – Label for household refrigerating appliances classified in energy efficiency classes A⁺⁺⁺ to C (except for wine storage appliances), except that items V and VI shall be replaced by information as to the rated capacity, in number of standard bottles of 75 centilitres, that may be fitted in the appliance in accordance with the manufacturer's instructions.

B – Label Design

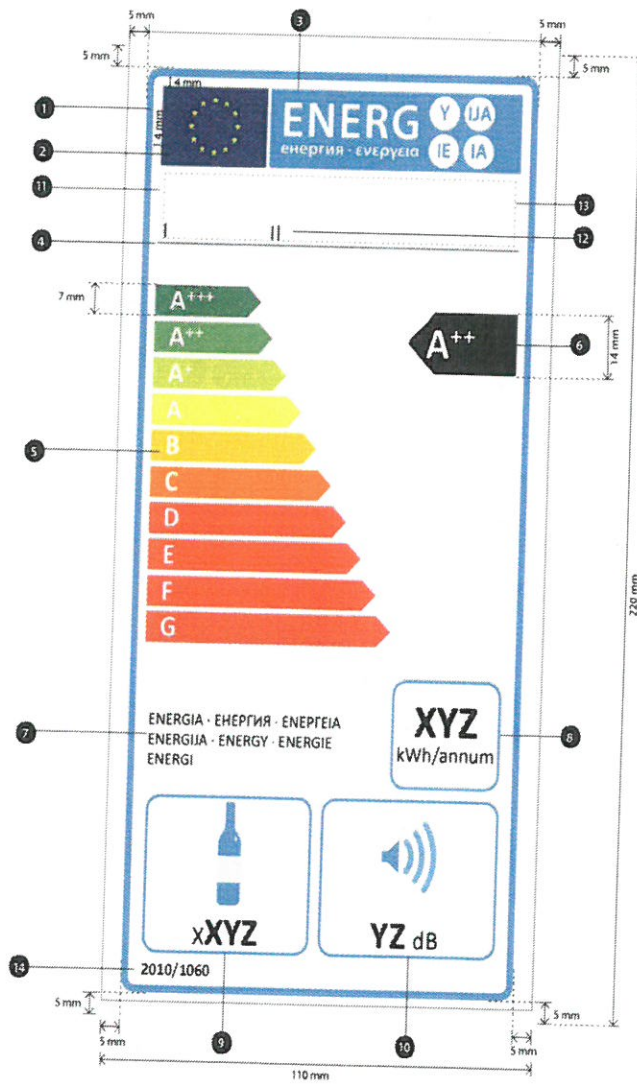

Whereby –

- (a) (i) the label shall be at least 110 millimetres wide and 220 millimetres high;
- (ii) where the label is printed in a larger format, its content shall nevertheless remain proportionate to the specifications above;
- (b) the background of the label shall be white;
- (c) colours shall be CMYK – cyan, magenta, yellow and black, following this example: 00-70-X-00: 0% cyan, 70 per cent magenta, 100% yellow, 0% black;
- (d) the label shall fulfil all of the following requirements (numbers refer to the figure above) –
 1. the EU label –
border stroke: 5 pt – colour: cyan 100% – round corners: 3.5 millimetres;
 2. the EU logo –
colours: X-80-00-00 and 00-00-X-00;
 3. the energy label –
colour: X-00-00-00;
pictogram as depicted: EU logo + energy label: width: 92 millimetres, height: 17 millimetres;
 4. the sub-logos border –
1 pt – colour: cyan 100% – length: 92.5 millimetres;
 5. the A-G scale –
arrow: height: 7 millimetres, gap: 0.75 millimetres
– colours –

highest class: X-00-X-00;
second class: 70-00-X-00;
third class: 30-00-X-00;
fourth class: 00-00-X-00;
fifth class: 00-30-X-00;
sixth class: 00-70-X-00;
last class(es): 00-X-X-00;

text: **calibri bold 19 pt, capitals and white; '+' symbols:**
calibri bold 13 pt, capitals, white aligned on a single row;

6. the energy efficiency class –

arrow: width: 26 millimetres, height: 14 millimetres, 100%
black;

text: **calibri bold 29 pt, capitals and white; '+' symbols:**
calibri bold 18 pt, capitals, white, aligned on a single row;

7. the energy –

text: **calibri regular 11 pt, capitals, black;**

8. the annual energy consumption –

border: 2 pt – colour: cyan 100% – round corners: 3.5
millimetres;

value: **calibri bold 30 pt, 100% black;**

second line: **calibri regular 14 pt, 100% black;**

9. the rated capacity in number of standard wine bottles –

border: 2 pt – colour: cyan 100% – round corners: 3.5
millimetres;

value: **calibri bold 28 pt, 100% black, calibri regular 15 pt, 100% black;**

10. the airborne acoustical noise emissions –

border: 2 pt – colour: Cyan 100 per cent – round corners: 3.5 millimetres;

value: **calibri bold 25 pt, 100% black; calibri regular 17 pt, 100% black;**

11. the supplier's name or trademark;
12. the supplier's model identifier;
13. the supplier's name or trademark and model identifier should fit in a space of 90 x 15 mm;
14. the numbering of the regulation –
text: **calibri bold 11 pt.**

B – Label Design(see below)

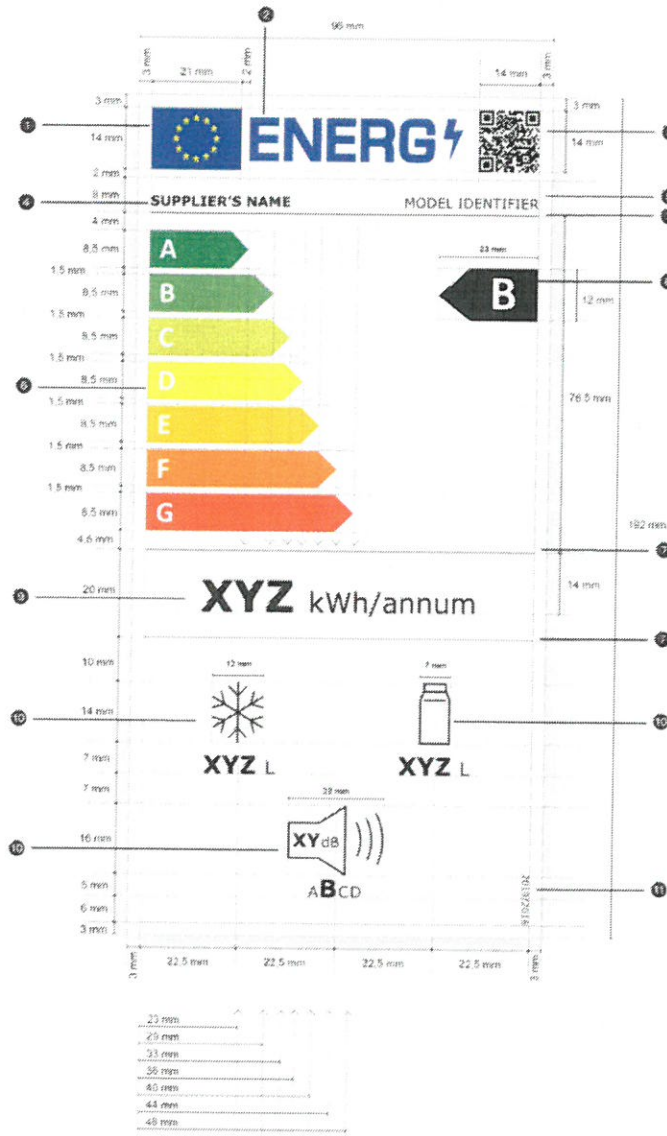

Whereby –

- (a) the labels shall be at least 96 mm wide and 192 mm high. Where the label is printed in a larger format, its content shall nevertheless remain proportionate to the specifications above;
- (b) the background of the label shall be 100% white;
- (c) the typefaces shall be Verdana and Calibri;
- (d) the dimensions and specifications of the elements constituting the label shall be as indicated in the label designs for refrigerating appliances and for wine storage appliances;
- (e) colours shall be CMYK – cyan, magenta, yellow and black, following this example: 0, 70, 100, 0: 0% cyan, 70% magenta, 100% yellow, 0% black;
- (f) the label shall fulfil all the following requirements (numbers refer to the figures above) –
 1. The colours of the EU logo shall be as follows –
 - the background: 100, 80, 0, 0;
 - the stars: 0, 0, 100, 0;
 2. The colour of the energy logo shall be: 100, 80, 0, 0;
 3. The QR code shall be 100% black;
 4. The supplier's name shall be 100% black and in Verdana Bold, 9 pt;
 5. The model identifier shall be 100% black and in Verdana Bold, 9 pt;
 6. The A to G scale shall be as follows –
 - the letters of the energy efficiency scale shall be 100% white and in Calibri Bold 19 pt; the letters shall be

-
- centred on an axis at 4,5 mm from the left side of the arrows;
- the colours of the A to G scale arrows shall be as follows;
 - A-class: 100, 0, 100, 0;
 - B-class: 70, 0, 100, 0;
 - C-class: 30, 0, 100, 0;
 - D-class: 0, 0, 100, 0;
 - E-class: 0, 30, 100, 0;
 - F-class: 0, 70, 100, 0;
 - G-class: 0, 100, 100, 0;
7. The internal dividers shall have a weight of 0,5 pt and the colour shall be 100% black;
 8. The letter of the energy efficiency class shall be 100% white and in Calibri Bold 33 pt. The energy efficiency class arrow and the corresponding arrow in the A to G scale shall be positioned in such a way that their tips are aligned. The letter in the energy efficiency class arrow shall be positioned in the centre of the rectangular part of the arrow which shall be 100% black;
 9. The annual energy consumption value shall be in Verdana Bold 28 pt; 'kWh/annum' shall be in Verdana Regular 18 pt. The value and unit shall be centred and 100% black;
 10. The pictograms shall be as shown in the label design and as follows:
 - the pictograms' lines shall have a weight of 1, 2 pt and they and the texts (numbers and units) shall be 100% black;

- the text under the pictogram(s) shall be Verdana Bold 16 pt with the unit in Verdana Regular 12 pt, and it shall be centred under the pictogram;
 - for refrigerating appliances, except wine storage appliances: if the appliance contains only frozen compartment(s) or only unfrozen compartment(s), only the relevant pictogram in the top row, as set out under the label content VII and VIII, shall be shown and centred between the two vertical borders of the energy label;
 - the airborne acoustical noise emission pictogram: the number of decibels in the loudspeaker shall be in Verdana Bold 12 pt, with the unit 'dB' in Verdana Regular 9 pt; the range of noise classes (A to D) shall be centred under the pictogram, with the letter of the applicable noise class in Verdana Bold 16 pt and the other letters of the noise classes in Verdana Regular 10 pt;
11. The number of the regulation shall be 100% black and in Verdana Regular 6 pt.

Type 2 – Label for wine storage appliances

A – Label Content
(see below)

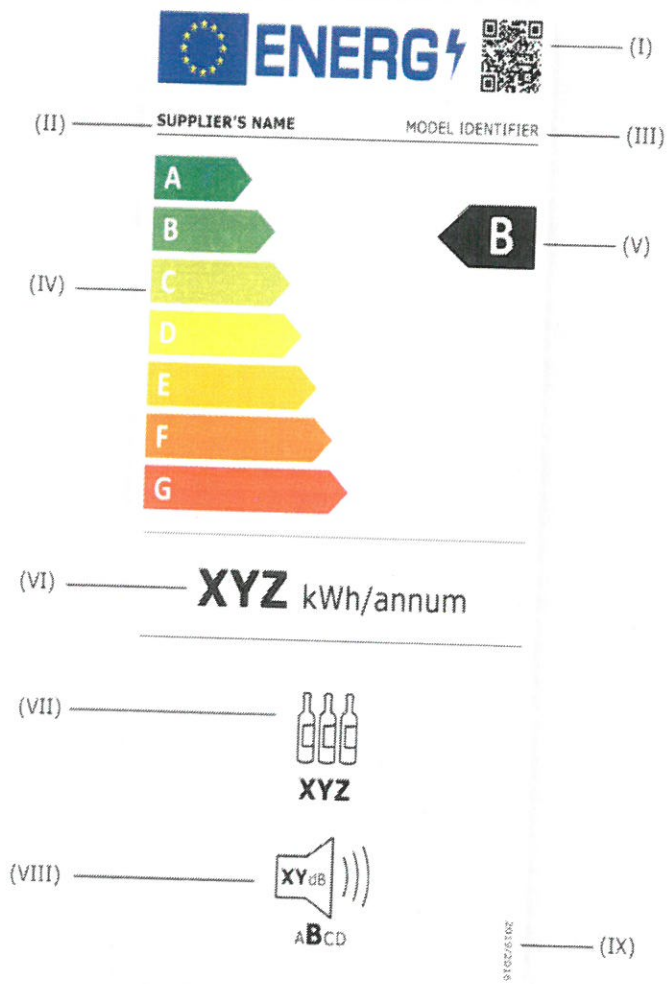

The following information shall be included in the label –

- (I) the QR Code;
- (II) supplier's name or trade mark;
- (III) supplier's model identifier;
- (IV) scale of energy efficiency classes from A to G;
- (V) the energy efficiency class determined in accordance with Annex II of the Commission Delegated Regulation (EU) 2019/2016;
- (VI) AE, expressed in kWh per year and rounded to the nearest integer;
- (VII) the number of standard wine bottles that can be stored in the wine storage appliance;
- (VIII) airborne acoustical noise emissions expressed in dB(A) re 1 pW, rounded to the nearest integer. The air borne acoustical noise emission class, as set out in Table 2 of the Commission Delegated Regulation (EU) 2019/2016;
- (IX) the number of the Regulation, that is '2019/2016'.

**B – Label Design
(see below)**

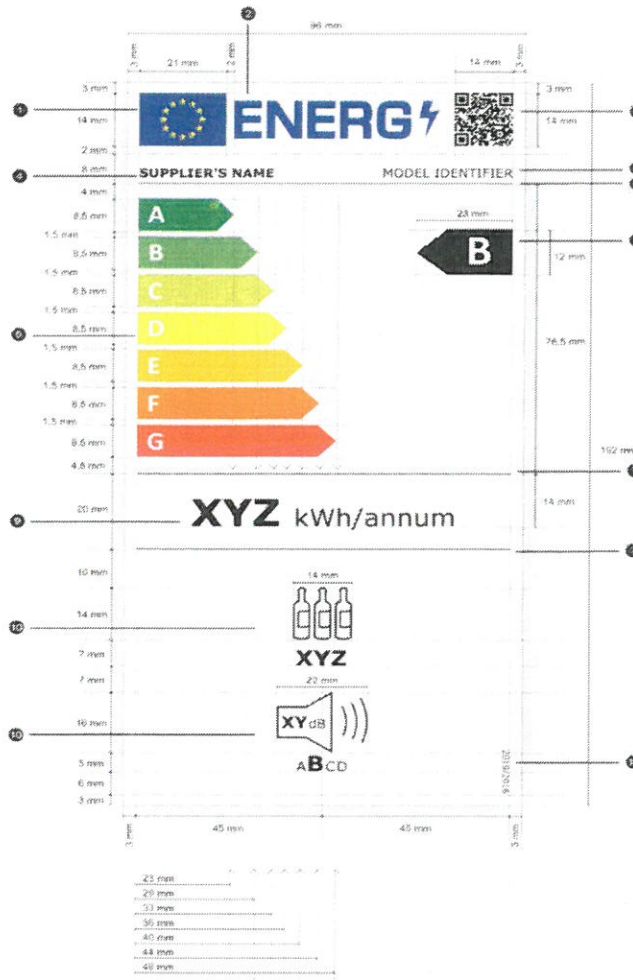

The design of the label shall be similar to the design of the label for Type 1 – Label for refrigerating appliances (except for wine storage appliances).

**PART II – HOUSEHOLD ELECTRIC OVENS
(MS 204)**

(Commission Delegated Regulation (EU) 65/2014)

(see below)

A – Label Content

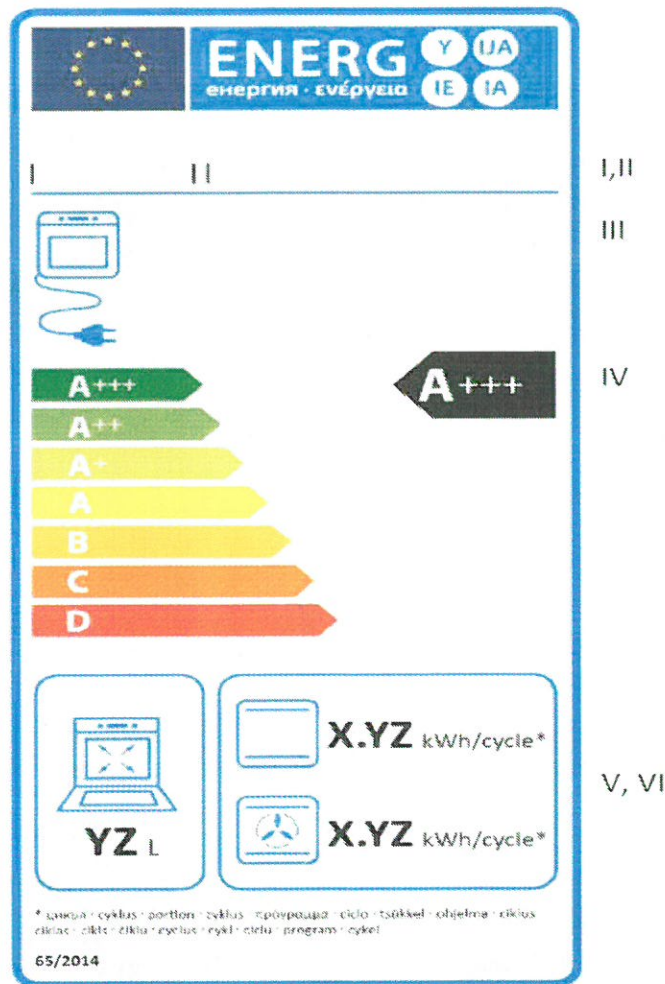

The following information shall be included in the label –

- (I) the supplier's name or trade mark;
- (II) the supplier's model identifier, where 'model identifier' means the code, usually alphanumeric, which distinguishes a specific domestic oven model from other models with the same trade mark or supplier's name;
- (III) the energy source of the domestic oven;
- (VI) the energy efficiency class of the cavity determined in accordance with Clause 4.2. The head of the arrow containing the indicator letter shall be placed at the same height as the head of the arrow of the relevant energy efficiency class;
- (V) the usable volume of the cavity in litres, rounded to the nearest integer;
- (VII) the energy consumption per cycle expressed in kWh/cycle (electricity consumption) for the heating function(s) (conventional and if available the forced air convection) of the cavity based on standard load determined in accordance with the test procedures, rounded to the second decimal place ($EC_{\text{electric cavity}}$).

B – Label Design

(see below)

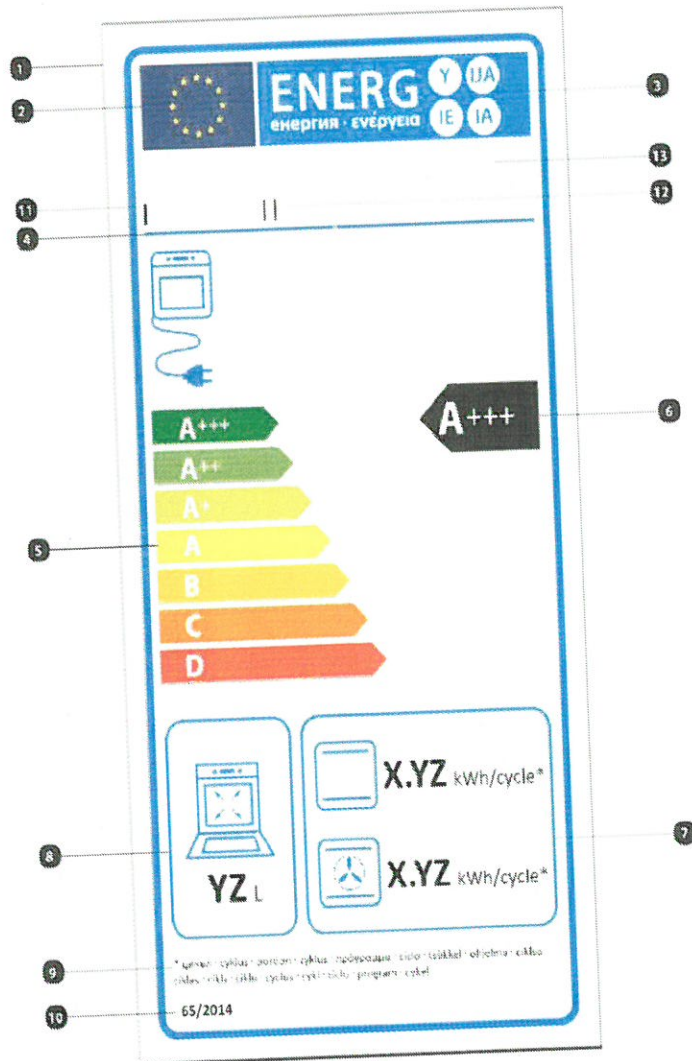

Whereby –

- (a) (i) the label shall be at least 85 mm wide and 170 mm high;
- (ii) where the label is printed in a larger format, its content shall nevertheless remain proportionate to the specifications above;
- (b) the background shall be white;
- (c) the colours shall be CMYK — cyan, magenta, yellow and black, following this example: 00-70-X-00: 0% cyan, 70% magenta, 100% yellow, 0% black;
- (d) the label shall fulfil all of the following requirements (numbers refer to the figure above) –
 1. the border stroke –
4 pt–colour: cyan 100% – round corners: 3 mm;
 2. the EU logo –
colours: X-80-00-00 and 00-00-X-00;
 3. the energy logo –
colour: X-00-00-00; pictogram as depicted: EU logo + energy label: width: 70 mm, height: 14 mm;
 4. the sub-logos border –
1,5 pt–colour: cyan 100% – length: 70 mm;
 5. the scale of energy classes –
arrow: height: 5,5 mm, gap: one mm –colours –
highest class: X-00-X-00;
second class: 70-00-X-00;
third class: 30-00-X-00;
fourth class: 00-00-X-00;

- fifth class: 00-30-X-00;
sixth class: 00-70-X-00;
last class: 00-X-X-00;
text: Calibri bold 18 pt, capitals and white; '+' symbol:
Calibri bold 12 pt, white, aligned on a single row;
6. the energy efficiency class –
arrow: width: 20 mm, height: 10 mm, 100% black;
text: Calibri bold 24 pt, capitals and white; '+' symbol:
Calibri bold 18 pt, white, aligned on a single row;
 7. the energy consumption per cycle –
border: 1,5 pt – colour: cyan 100% – round corners: 3 mm;
value: Calibri bold 19 pt, 100% black; and Calibri regular
10 pt, 100% black;
 8. the volume –
border: 1,5 pt — colour: cyan 100% — round corners:
3 mm;
value: Calibri bold 20 pt, 100% black; and Calibri regular
10 pt, 100% black;
 9. the asterisk –
calibri regular 6 pt, 100% black;
 10. the numbering of the Regulation –
calibri bold 10 pt, 100% black;
 11. the supplier's name or trademark;
 12. the supplier's model identifier;
 13. the suppliers' name or trade mark and model identifier
should fit in a space of 70 mm × 13 mm.

**PART III – HOUSEHOLD ELECTRIC DISHWASHERS
(MS 205)**

A – Label Content

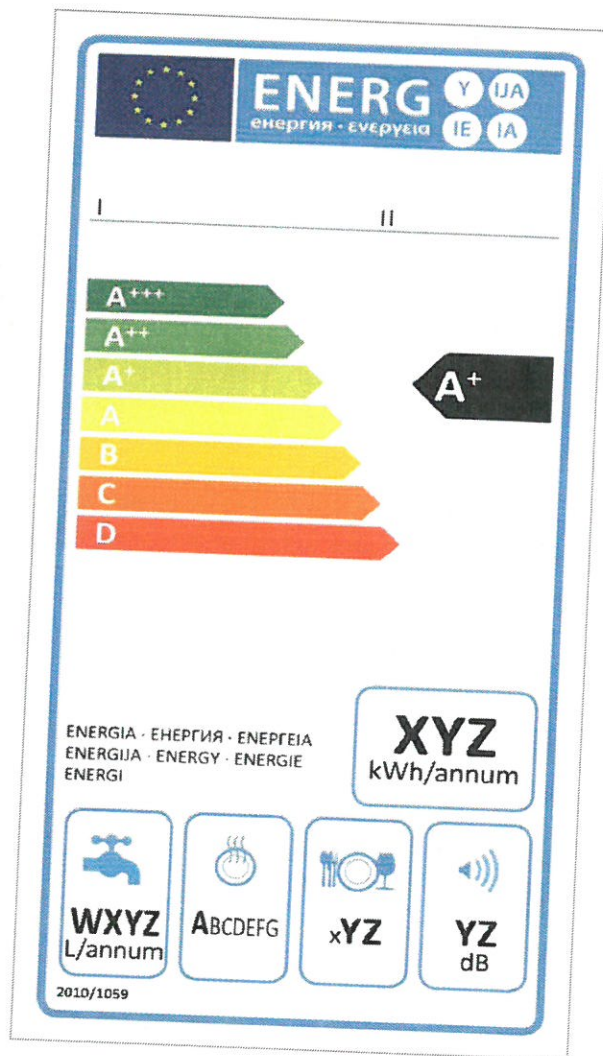

I
II

III

IV

V
VI
VII
VIII

The following information shall be included in the label –

- (I) the supplier's name or trade mark;
- (II) the supplier's model identifier, where "model identifier" means the code, usually alphanumeric, which distinguishes a specific household dishwasher model from other models with the same trade mark or supplier's name;
- (III) the energy efficiency class determined in accordance with Clause 4.2 of MS 205; the head of the arrow containing the energy efficiency class of the household dishwasher shall be placed at the same height as the head of the arrow of the relevant energy efficiency class;
- (IV) the annual energy consumption (AE_c) in kWh per year, rounded up to the nearest integer and calculated in accordance with point 1(b) of Annex IV of MS 205;
- (V) the annual water consumption (AW_c) in litres per year, rounded up to the nearest integer and calculated in accordance with point 3 of Annex IV of MS 205;
- (VI) the drying efficiency class determined in accordance with Clause 4.3 of MS 205;
- (VII) the rated capacity in standard place settings, for the standard cleaning cycle;
- (VIII) the airborne acoustical noise emissions expressed in dB(A) re 1 pW and rounded to the nearest integer.

By way of derogation, where a model has been granted an 'EU Ecolabel', a copy of the EU Ecolabel may be added.

B – Label Design

(see below)

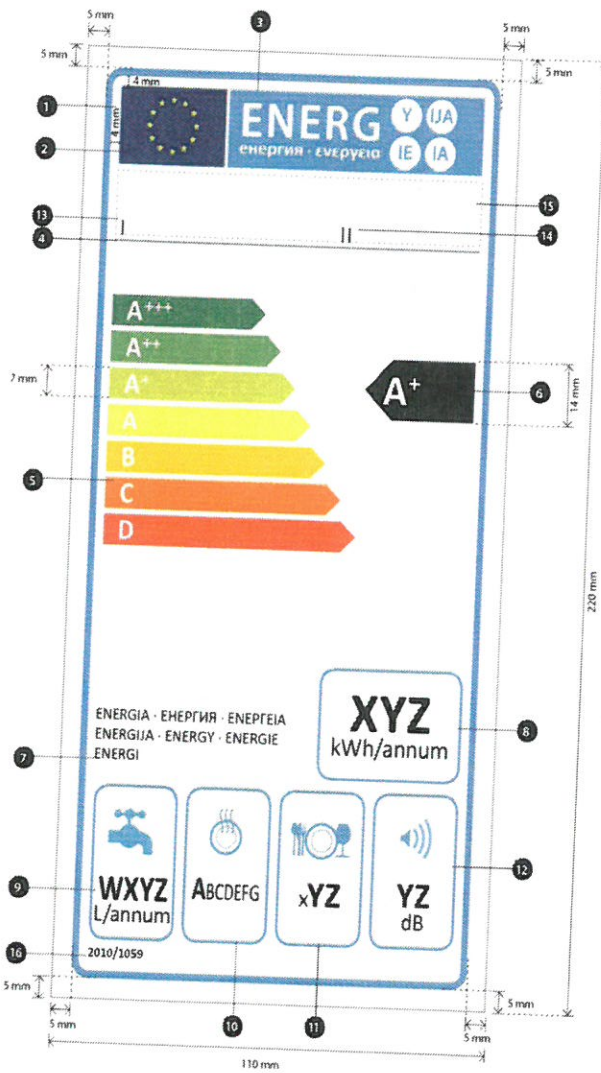

Whereby –

- (a) (i) the label shall be at least 110 millimetres wide and 220 millimetres high;
- (ii) where the label is printed in a larger format, its content must nevertheless remain proportionate to the specifications above;
- (b) the background shall be white;
- (c) the colours shall be CMYK – cyan, magenta, yellow and black, following this example: 00-70-X-00: 0% cyan, 70% magenta, 100%yellow, 0% black;
- (d) the label shall fulfil all of the following requirements (numbers refer to the figure above) –
 - 1. the border stroke –
5 pt – colour: cyan 100% – round corners: 3.5 millimetres;
 - 2. the EU logo –
colours: X-80-00-00 and 00-00-X-00;
 - 3. the energy logo
colour: X-00-00-00;
the EU logo and energy logo (combined): width: 92 millimetres, height: 17 millimetres;
 - 4. the sub-logos border –
1 pt – colour: cyan 100% – length: 92.5 millimetres;
 - 5. the A-G scale –
arrow: height: 7 millimetres, gap: 0.75 millimetres
– colours –
highest class: X-00-X-00;

second class: 70-00-X-00;

third class: 30-00-X-00;

fourth class: 00-00-X-00;

fifth class: 00-30-X-00;

sixth class: 00-70-X-00;

last class(es): 00-X-X-00;

text: calibri bold 18 pt, capitals and white, '+' symbols:
Calibri bold 12 pt, capitals, white, aligned on a single row;

6. the energy efficiency class –

arrow: width: 26 millimetres, height: 14 millimetres, 100% black;

text: calibri bold 29 pt, capitals and white, '+' symbols:
calibri bold 18 pt, capitals, white and aligned on a single row;

7. the energy –

text: calibri regular 11 pt, capitals, 100% black.

8. the annual energy consumption –

border: 2 pt – colour: cyan 100% – round corners: 3.5 millimetres;

value: calibri bold 37 pt, 100% black;

second line: calibri regular 17 pt, 100% black.

9. the annual water consumption –

border: 2 pt – colour: cyan 100%- round corners: 3.5 mm;

value: calibri bold 24 pt, 100% black and calibri regular 16 pt, 100 per cent black;

10. the drying efficiency class –
border: 2 pt – colour: cyan 100% – round corners: 3.5 millimetres;
value:calibri regular 16 pt, horizontal scale 75%, 100% black and calibri bold 22 pt, horizontal scale 75%, 100% black;
11. the rated capacity –
border: 2 pt – colour: cyan 100% – round corners: 3.5 millimetres;
value: calibri bold 24 pt, 100% black; and calibri regular 16 pt, 100% black’;
12. the noise emissions –
border: 2 pt – colour: Cyan 100% – round corners: 3.5 millimetres;
value: calibri bold 24 pt, 100% black; and calibri regular 16 pt, 100% black;
13. the supplier’s name or trademark;
14. the supplier’s model identifier;
15. the supplier’s name or trademark and model identifier should fit in a space of 92 x 15 mm;
16. the numbering of the regulation –
text: Calibri bold 9 pt, 100% black.

(Commission Delegated Regulations (EU) 2019/2017)

A – Label Content

(see below)

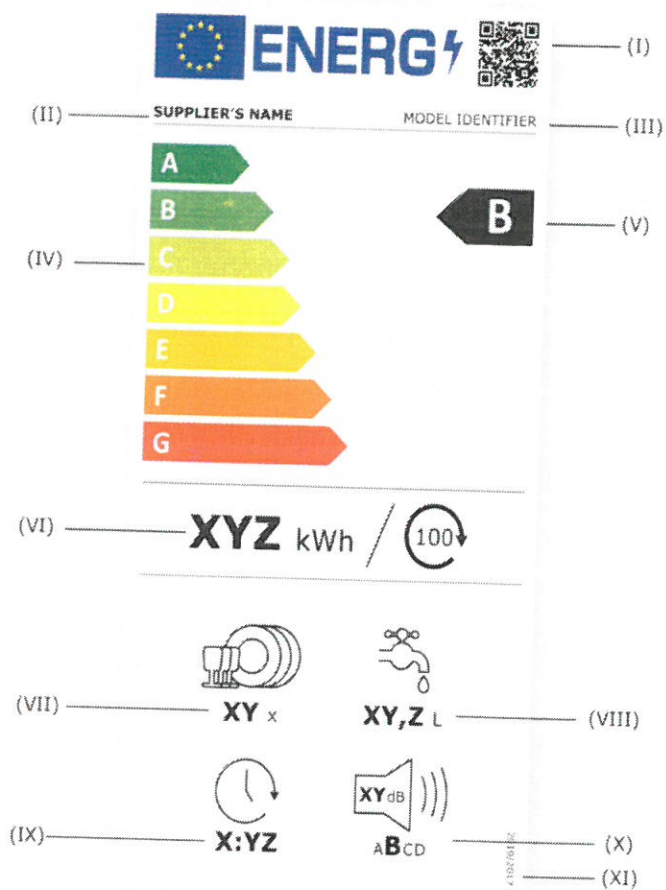

The following information shall be included in the label:

- (I) the QR Code;
- (II) supplier's name or trade mark;
- (III) supplier's model identifier;
- (IV) scale of energy efficiency classes from A to G;
- (V) the energy efficiency class determined in accordance with point A of Annex II of the Commission Delegated Regulation (EU) 2019/2017;
- (VI) eco programme energy consumption (EPEC) in kWh per 100 cycles, rounded to the nearest integer;
- (VII) rated capacity in standard place settings, for the eco programme;
- (VIII) eco programme water consumption (EPWC) in litres per cycle, rounded to one decimal place;
- (IX) duration of the eco programme in h:min rounded to the nearest minute;
- (X) airborne acoustical noise emissions expressed in dB(A) with respect to 1 pW and rounded to the nearest integer, and airborne acoustic noise emission class, determined in accordance with point B of Annex II of the Commission Delegated Regulations (EU) 2019/2017;
- (XI) the number of the Regulation, that is, '2019/2017'.

B – Label Design

(see below)

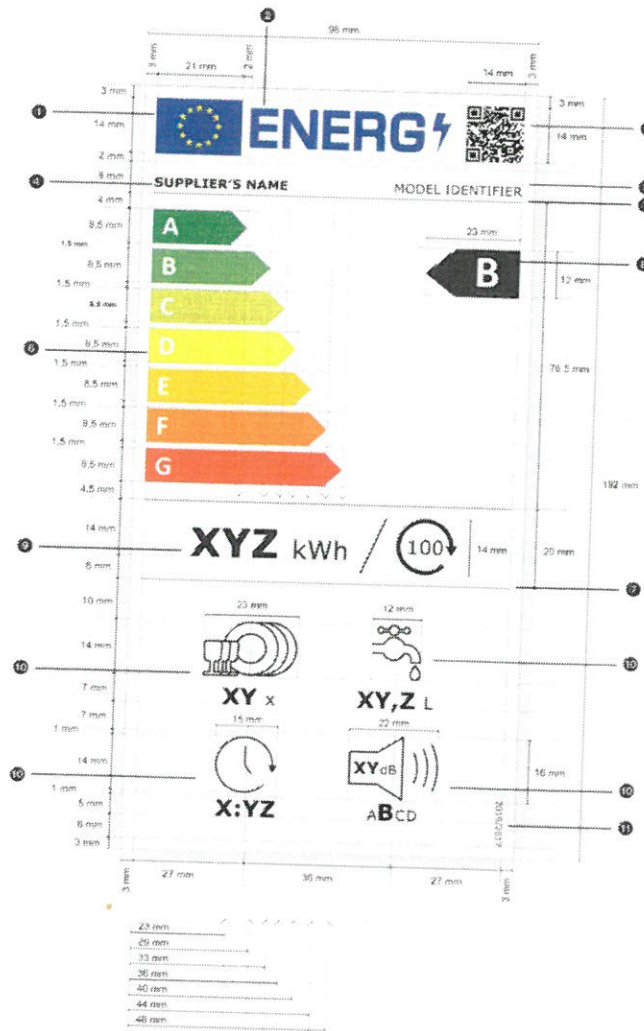

Whereby –

- (a) the labels shall be at least 96 mm wide and 192 mm high. Where the label is printed in a larger format, its content shall nevertheless remain proportionate to the specifications above;
- (b) the background of the label shall be 100% white;
- (c) the typefaces shall be Verdana and Calibri;
- (d) the dimensions and specifications of the elements constituting the label shall be as indicated in the label designs for household dishwashers;
- (e) colours shall be CMYK – cyan, magenta, yellow and black, following this example: 0, 70, 100, 0: 0% cyan, 70% magenta, 100% yellow, 0% black;
- (f) the label shall fulfil all the following requirements (numbers refer to the figures above) –
 1. the colours of the EU logo shall be as follows:
 - the background: 100, 80, 0, 0;
 - the stars: 0, 0, 100, 0;
 2. the colour of the energy logo shall be: 100, 80, 0, 0;
 3. the QR code shall be 100% black;
 4. the supplier's name shall be 100% black and in Verdana Bold, 9 pt;
 5. the model identifier shall be 100% black and in Verdana Bold, 9 pt;
 6. the A to G scale shall be as follows –
 - the letters of the energy efficiency scale shall be 100% white and in Calibri Bold 19 pt; the letters shall be

-
- centred on an axis at 4,5 mm from the left side of the arrows;
- the colours of the A to G scale arrows shall be as follows –
 - A-class: 100, 0, 100, 0;
 - B-class: 70, 0, 100, 0;
 - C-class: 30, 0, 100, 0;
 - D-class: 0, 0, 100, 0;
 - E-class: 0, 30, 100, 0;
 - F-class: 0, 70, 100, 0;
 - G-class: 0, 100, 100, 0;
7. the internal dividers shall have a weight of 0,5 pt and the colour shall be 100% black;
 8. the letter of the energy efficiency class shall be 100% white and in Calibri Bold 33 pt. The energy efficiency class arrow and the corresponding arrow in the A to G scale shall be positioned in such a way that their tips are aligned. The letter in the energy efficiency class arrow shall be positioned in the centre of the rectangular part of the arrow which shall be 100% black;
 9. the value of the eco programme energy consumption per 100 cycles shall be in Verdana Bold 28 pt; 'kWh' shall be in Verdana Regular 18 pt; the number '100' in the pictogram representing 100 cycles shall be in Verdana Regular 14 pt. The value and unit shall be centred and 100% black;
 10. the pictograms shall be as shown in the label design and as follows –

- the pictograms' lines shall have a weight of 1, 2 pt and they and the texts (numbers and units) shall be 100% black;
 - the texts under the pictogram(s) shall be Verdana Bold 16 pt with the unit in Verdana Regular 12 pt, and they shall be centred under the pictogram;
 - the airborne acoustical noise emission pictogram: the number of decibels in the loudspeaker shall be in Verdana Bold 12 pt, with the unit 'dB' in Verdana Regular 9 pt; the range of noise classes (A to D) shall be centred under the pictogram, with the letter of the applicable noise class in Verdana Bold 16 pt and the other letters of the noise classes in Verdana Regular 10 pt;
11. The number of the regulation shall be 100% black and in Verdana Regular 6 pt.
-